

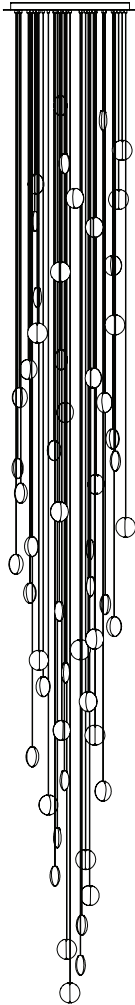

# OVA C55

---

## INSTALLATION INSTRUCTIONS



Designed by Matthew McCormick Studio®



# OVAC55

## PRODUCT DESCRIPTION

PENDANTS:	55
CANOPY:	Round 900mm (35.43") diameter x 50.5mm (1.99") deep
CABLE LENGTH:	Standard 3,000mm (118") coax cable 10,000mm (394") available upon request
VOLTAGE:	12V
WATTAGE:	110W
DIMMING:	Phase dimming (0-10V dimming request)
MOUNT TYPE:	Surface, Recessed and Remote mounting options



**READ IN FULL BEFORE COMMENCING WITH INSTALLATION**



## IMPORTANT SAFETY INSTRUCTIONS

- Ensure the supply voltage is the same as the rated luminary voltage
- Make sure the power supply is OFF before and during installation
- Low voltage connection MUST be done offline; switch off the circuit breaker before doing any connections (connecting the low voltage LED light live may result in damaging the LED)
- Polarity is critical - an inversion will result in a light not firing up
- Do not detach the ground cable from the terminal end when installing pendants

## INSTALLATION BY A CERTIFIED PROFESSIONAL

Matthew McCormick Studio (MMS) strongly recommends that installation be done by a certified electrician in accordance to relevant building codes within your jurisdiction. Failure to reference this instruction manual and/or meet proper certification/installation criteria may damage the fixture, in addition to voiding both the warranty and its certifications.

## QUESTIONS?

For additional assistance that cannot be answered within this instruction manual, please contact Matthew McCormick Studio directly to avoid product malfunction and/or damaging parts.

[info@matthewmccormick.ca](mailto:info@matthewmccormick.ca)

+ 1 888-290-0840

Monday through Friday, 9:00 - 4:30 PM, PST



# COMPONENT LIST

Ensure the items listed below are included in your product kit prior to initiating installation. If any items on the component list are missing, please contact Matthew McCormick Studio.

COMPONENT LIST - OVA C55		
ITEM	PART DESCRIPTION	QUANTITY
A	(i) Strain relief cover	55
	(ii) Screws	9
	(iii) Front plate	1
	(iv) Back plate	1
B	Black Strain relief	55
C	(i) Compact wago 5 conductor + wire (+/-)	28
	(ii) Compact wago 5+5 conductor	4
	(iii) Compact wago 3 conductor	2
D	Driver	2
E	(i) Coaxial cable	55
	(ii) Pendant	55
F	G4 bulb	55
G	Gloves	1
H	Allen wrench	1
I	Instruction manual	1

## TOOLS REQUIRED FOR INSTALLATION (BUT NOT INCLUDED IN KIT):

- Screws (for ceiling-mounting back plate, specific to ceiling type)

## PREPARATION:

- Before beginning assembly of product, make sure all componentry and tools are in hand. Compare the parts received with delivery checklist above; if any component is missing or damaged, do not attempt to assemble the product until you've contacted MMS.
- Do not discard any contents until after assembly is complete to avoid accidentally discarding small parts or hardware.

## IMPORTANT REMINDERS:

- We strongly recommend that a **certified electrician** installs your fixture.
- Keep flammable material away from the bulb.

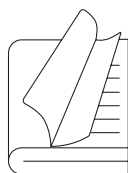
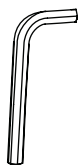
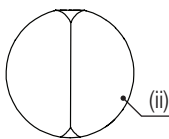
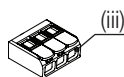
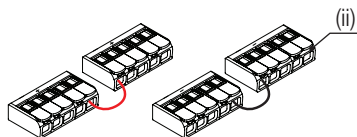
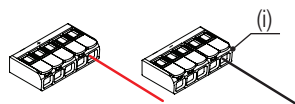
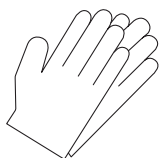
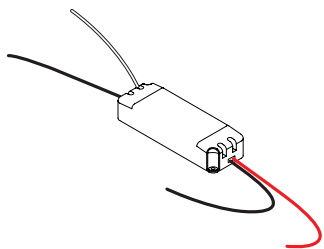
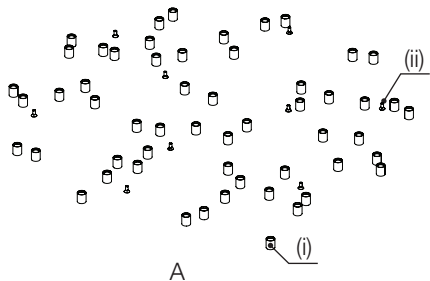
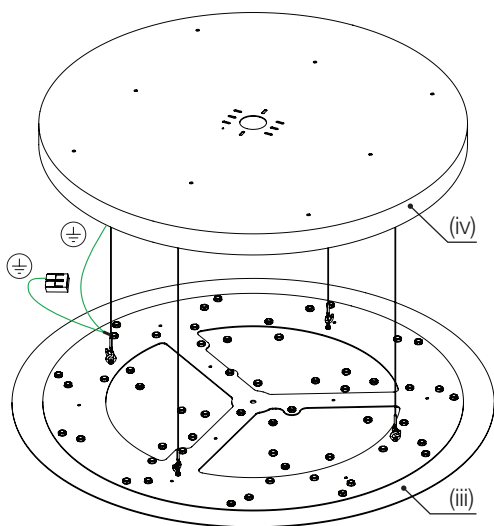

# INSTRUCTIONS

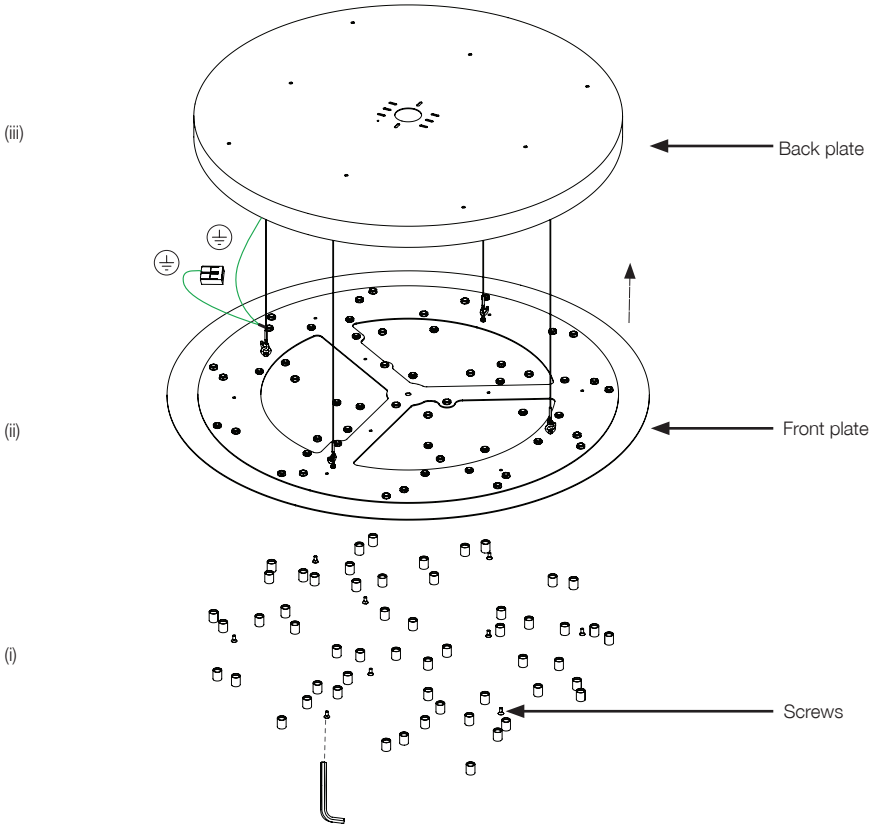

## 1

- (i) Use the Allen wrench to remove the nine screws on the front plate. Safety store screws aside.
- (ii) Separate the front plate from the back plate. Set aside.

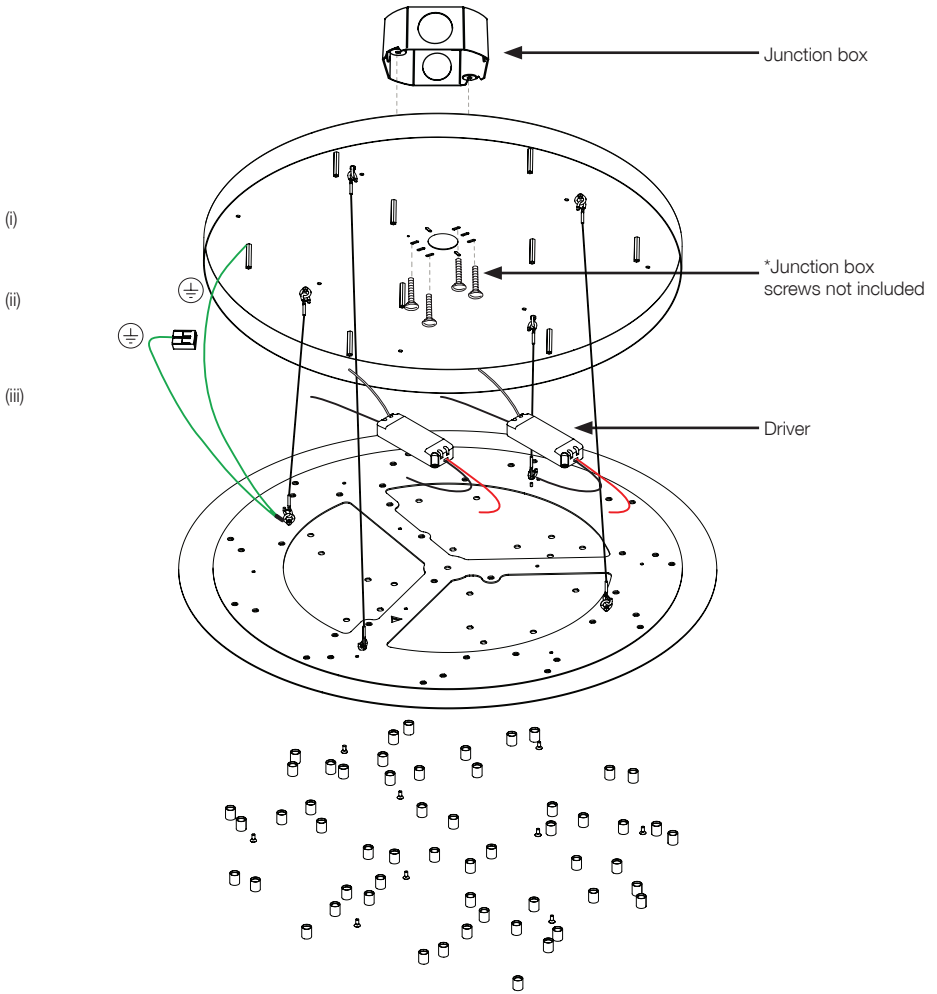

## 2

- (i) Affix the backplate to the junction box on the ceiling\*.
- (ii) Screw backplate to the ceiling. Extra backing is recommended.
- (iii) Fix the driver to the front plate using the provided adhesive tape.



# INSTRUCTIONS

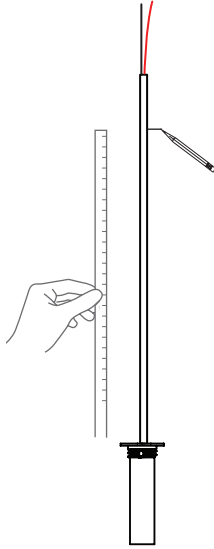

## 3

---

Determine the overall drop length of the fixture. Measure and set the cable lengths prior to affixing to the stain relief and front plate.



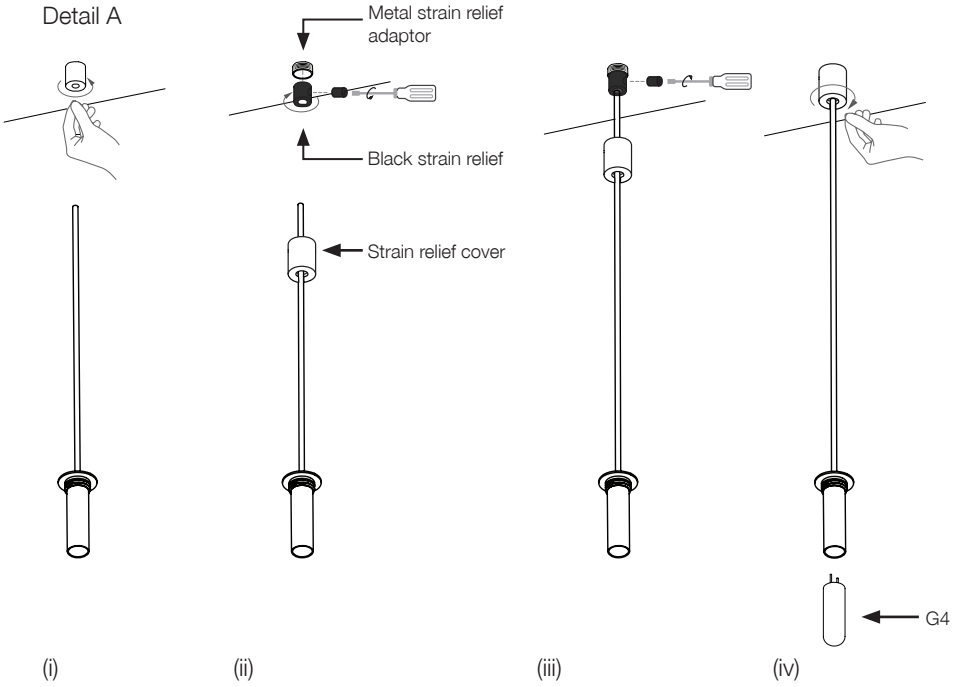
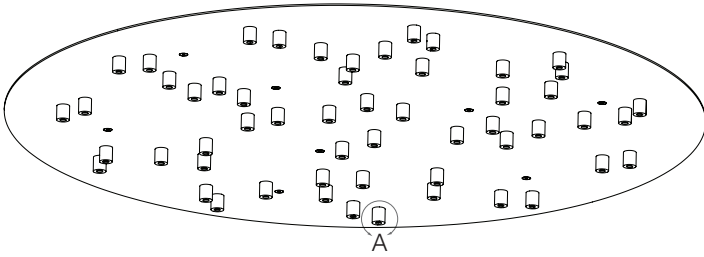

**4**

- (i) Unscrew the strain relief cover to expose the metal strain relief adaptor.
- (ii) Thread strain relief cover onto pendant wire, then screw black strain relief onto metal strain relief adaptor. Loosen setscrew.
- (iii) Thread pendant wire through strain relief to desired length and tighten setscrew. Gently tug on pendant wire to confirm pendant is secure.
- (iv) Finish by screwing the strain relief cover over the strain relief, and onto the metal strain relief adaptor. Repeat this process for all the pendants. Insert G4 bulb into socket.

 Do not trim cables to minimum length until installation is complete. This allows for any required adjustments. Coil any excess wire neatly into the canopy.

# INSTRUCTIONS

**⚠ CAUTION!** Ensure that the power breaker is disconnected prior to completing Step 5.

**⚠** Do not reverse the positive and negative connections; Doing so may compromise your safety.

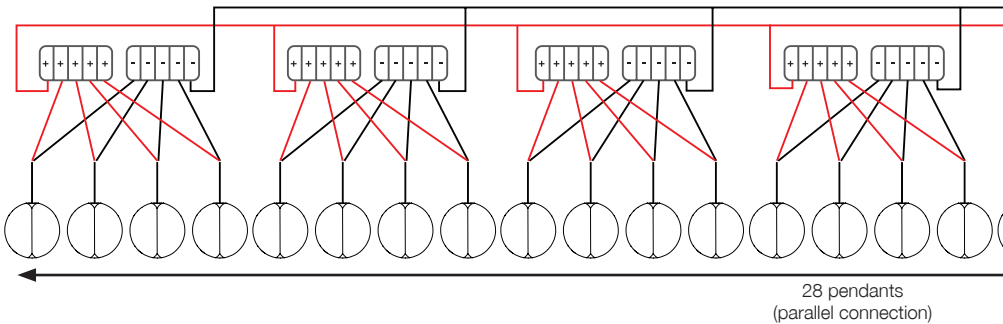
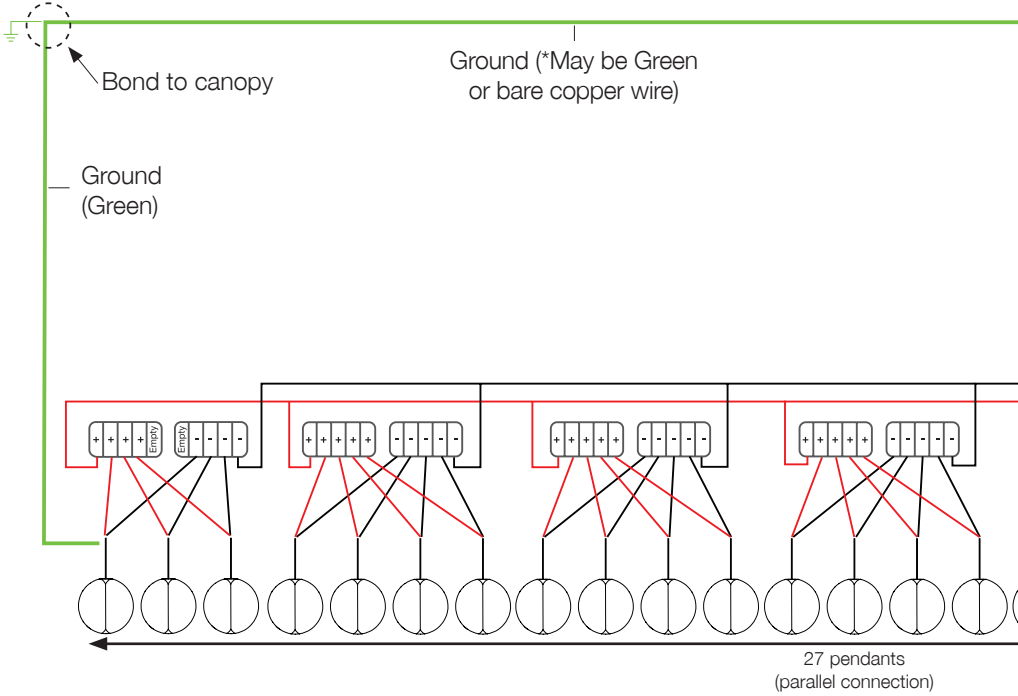

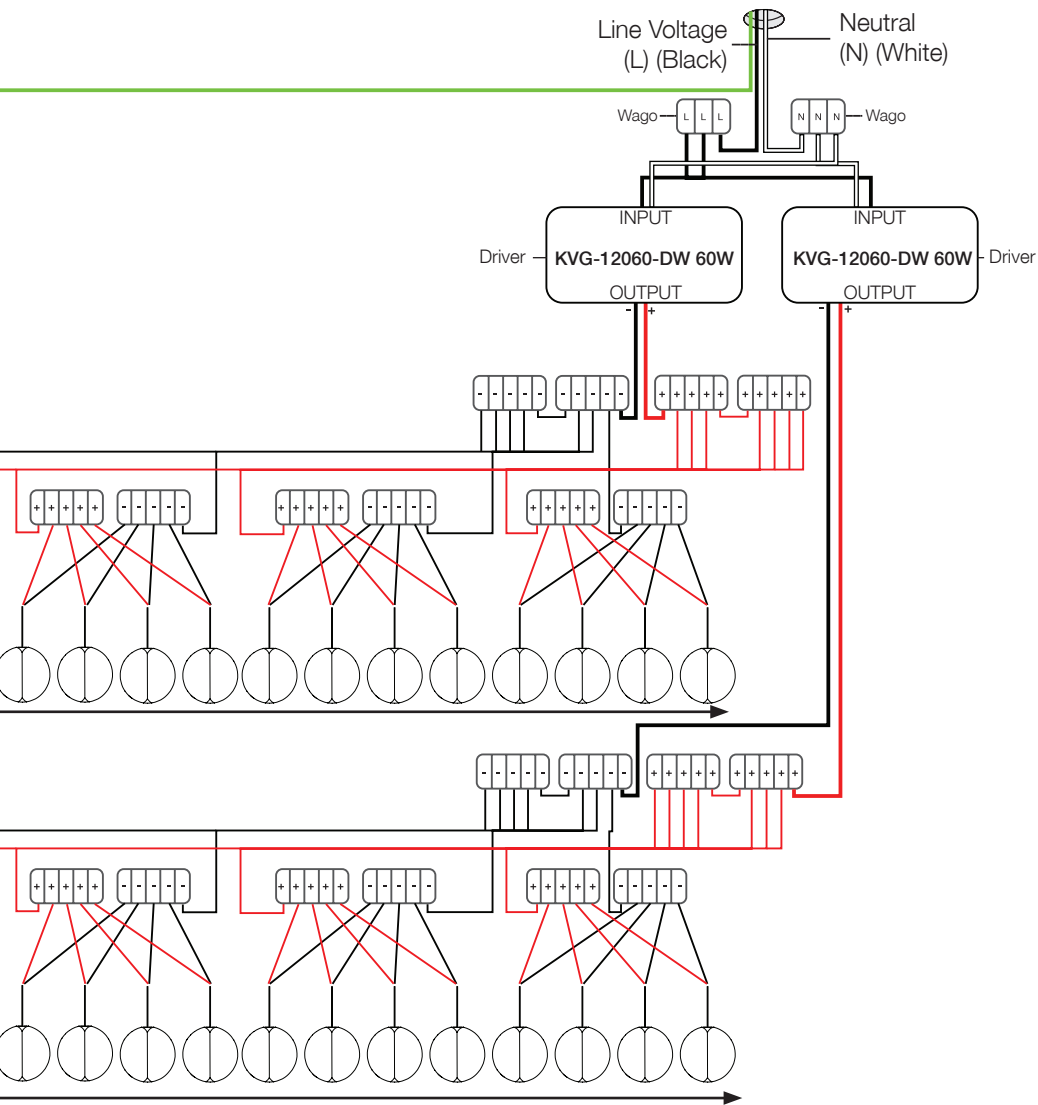

# INSTRUCTIONS

## 5

---

Connect the primary circuit on the LED Driver to input power by connecting power supplies to line voltage (L).

- Connect the Black Line Voltage (L) wire to the Black (-) wire of driver using wago.
- Connect the White Neutral (N) wire to the White (+) wire of driver using wago.
- The Ground wire\* (Green) in the junction box should be connected to the ground cable terminal for ground connection.

**Please note this setup is for Phase dimming. For detailed wiring instruction please see APPENDIX A. Refer to APPENDIX B for 0-10 dimming set up.**

## 6

---

Connect the light to the LED driver.

- From the output side of the driver connect the Black (-) wire to the Black (-) wire of the light using Wago.
- From the output side of the driver connect the Red (+) wire to the Red (+) wire of the light using Wago.

**The size and number of pendants connected to each driver should be respected.**

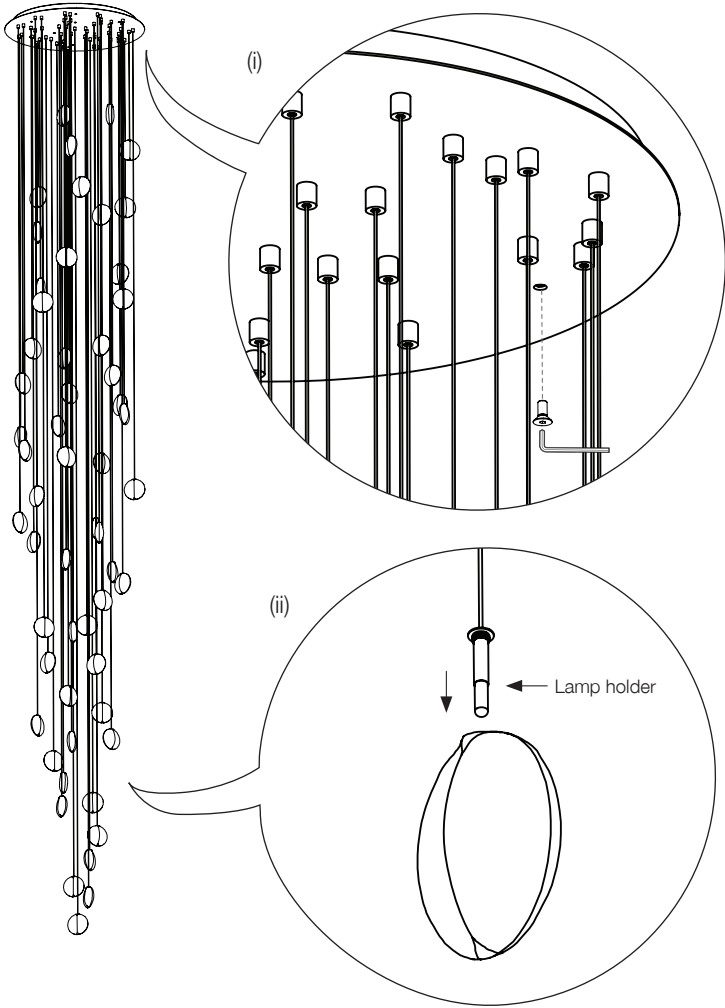

7

(i) Tuck the wiring neatly into the canopy. Affix the front plate to the back plate using the Allen wrench and the screws previously saved. Ensure cover is properly screwed down.

(ii) Carefully apply pressure to lamp holder while screwing it into Ova glass. Screw until lamp holder is flush with Ova glass.

**It is now safe to turn the breaker back on and operate the light.**



# WIRING INSTRUCTIONS: PHASE DIMMING

## APPENDIX A

### MECHANICAL SPECIFICATION

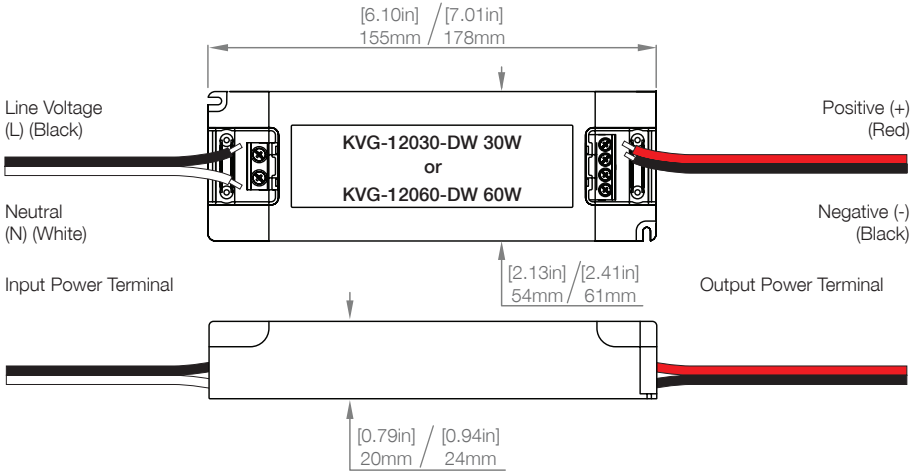

### FEATURES

- Output: Constant Voltage
- Range: 100-277VAC
- PFC design: Built-in active PFC function
- Efficiency: Up to 80%
- Protections: Short circuit/ over load/ over temperature
- Heat dissipation: Cooling by free air convection
- Waterproof performance: Full protection plastic housing, for dry, damp locations
- Dimming function: Phase dimming: work with forward phase, MLV and Reverse phase, ELV, TRIAC dimmers.
- 0-10V dimming: 0-10V/1-10V/Potentiometer/10V PWM 4 in 1
- Dimming range: 0-100%
- Certificate: UL / cUL / FCC / Class 2 / CE / ROHS / Reach





# WIRING INSTRUCTIONS: PHASE DIMMING

## APPENDIX A

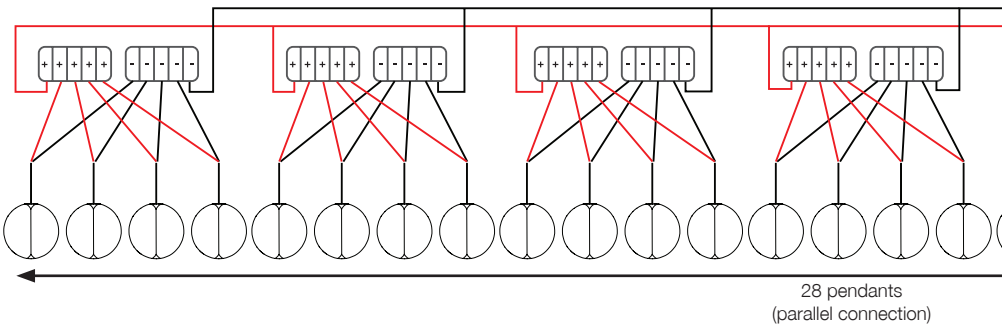
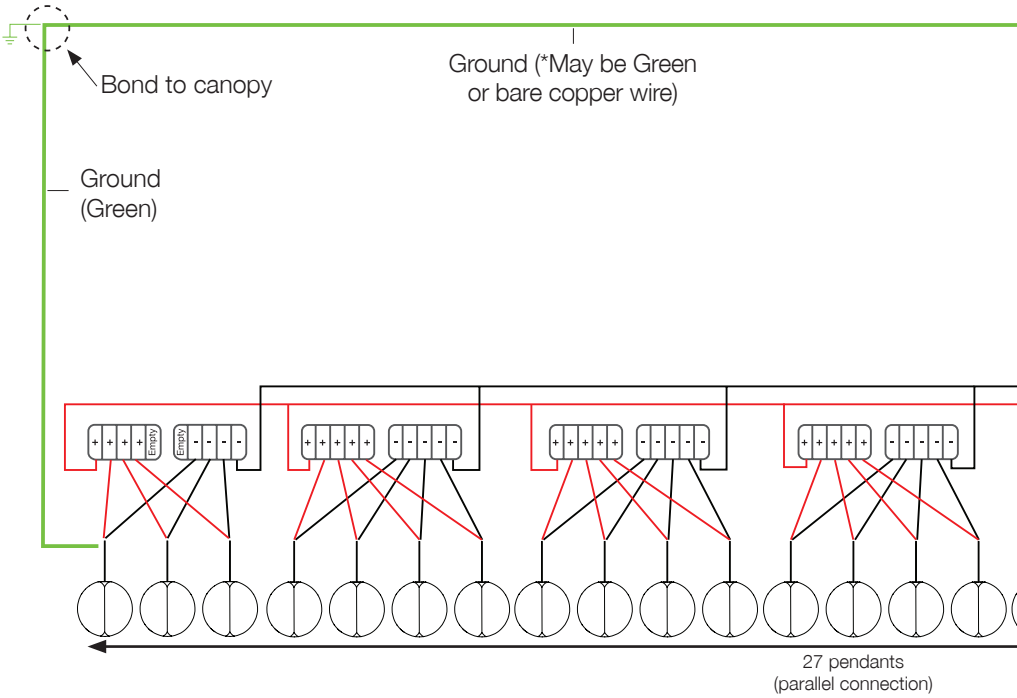

**⚠ CAUTION!** Ensure that the power breaker is disconnected prior to starting.

**⚠** Do not reverse the positive and negative connections; Doing so may compromise your safety.



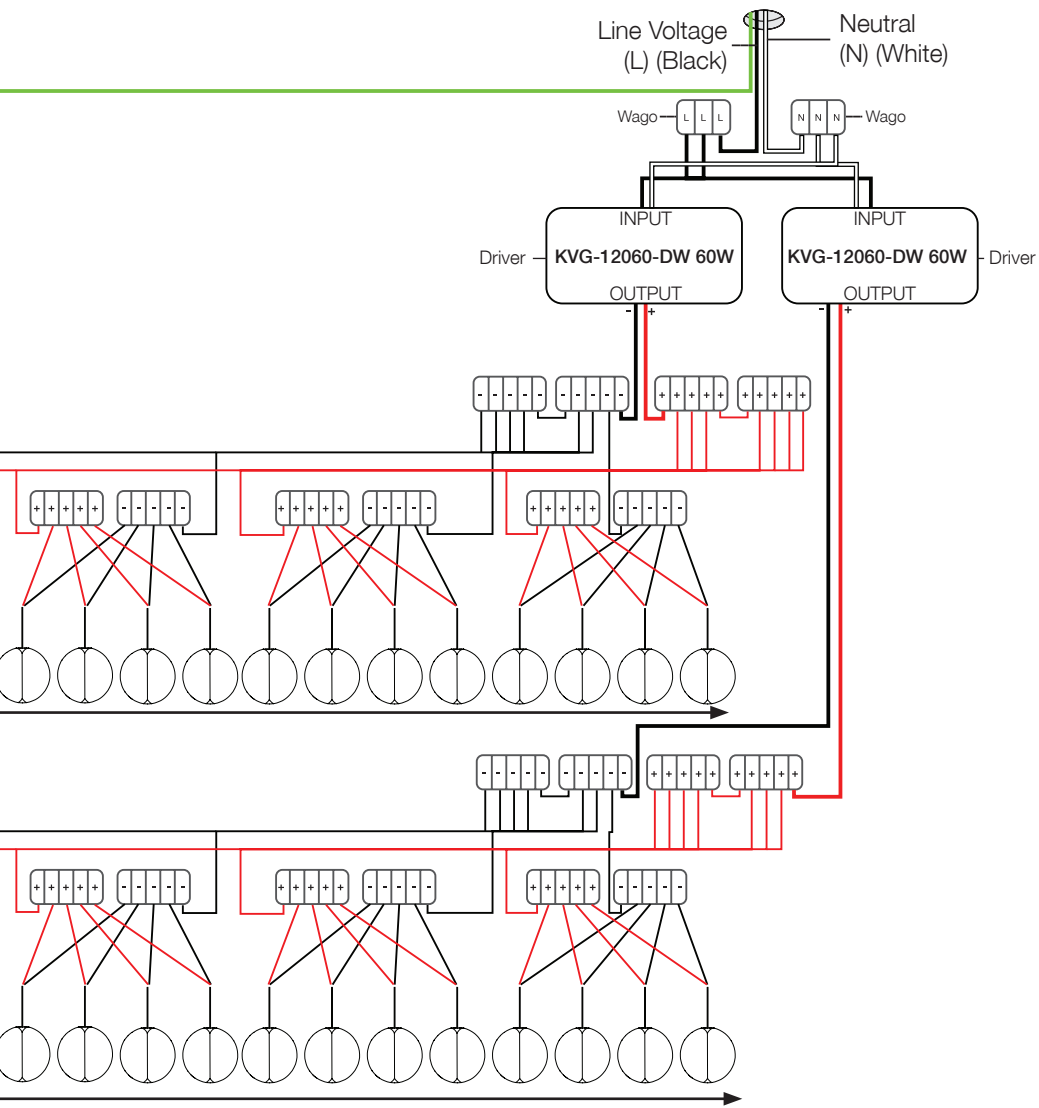

**NOTE: Outside of North America, the Neutral and Line Voltage wire colours may be different.**



# WIRING INSTRUCTIONS: 0-10V DIMMING

## APPENDIX B

### MECHANICAL SPECIFICATION

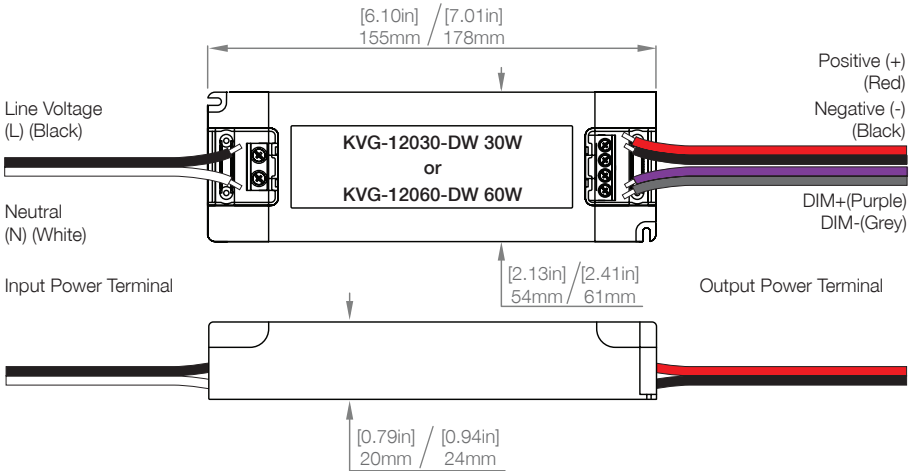

### FEATURES

- Output: Constant Voltage
- Range: 100-277VAC
- PFC design: Built-in active PFC function
- Efficiency: Up to 80%
- Protections: Short circuit/ over load/ over temperature
- Heat dissipation: Cooling by free air convection
- Waterproof performance: Full protection plastic housing, for dry, damp locations
- Dimming function: Phase dimming: work with forward phase, MLV and Reverse phase, ELV, TRIAC dimmers.
- 0-10V dimming: 0-10V/1-10V/Potentiometer/10V PWM 4 in 1
- Dimming range: 0-100%
- Certificate: UL / cUL / FCC / Class 2 / CE / ROHS / Reach





# WIRING INSTRUCTIONS: 0-10V DIMMING

## APPENDIX B

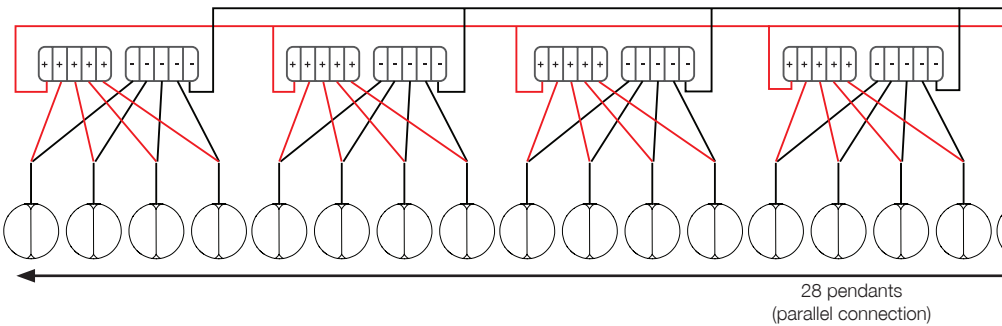
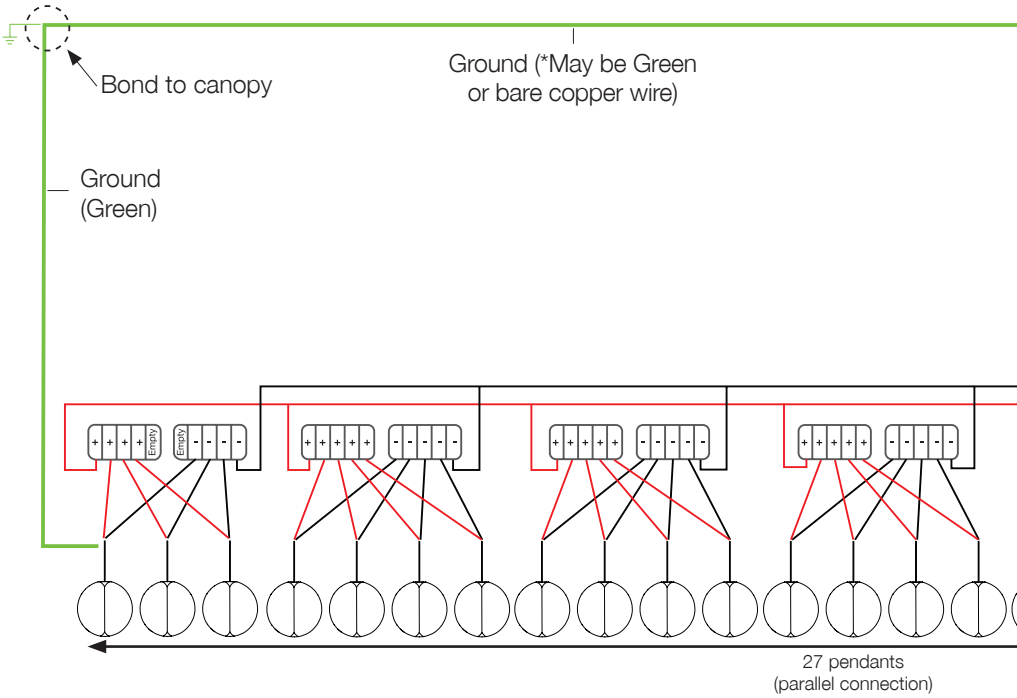

**⚠ CAUTION!** Ensure that the power breaker is disconnected prior to starting.

**⚠** Do not reverse the positive and negative connections; Doing so may compromise your safety.

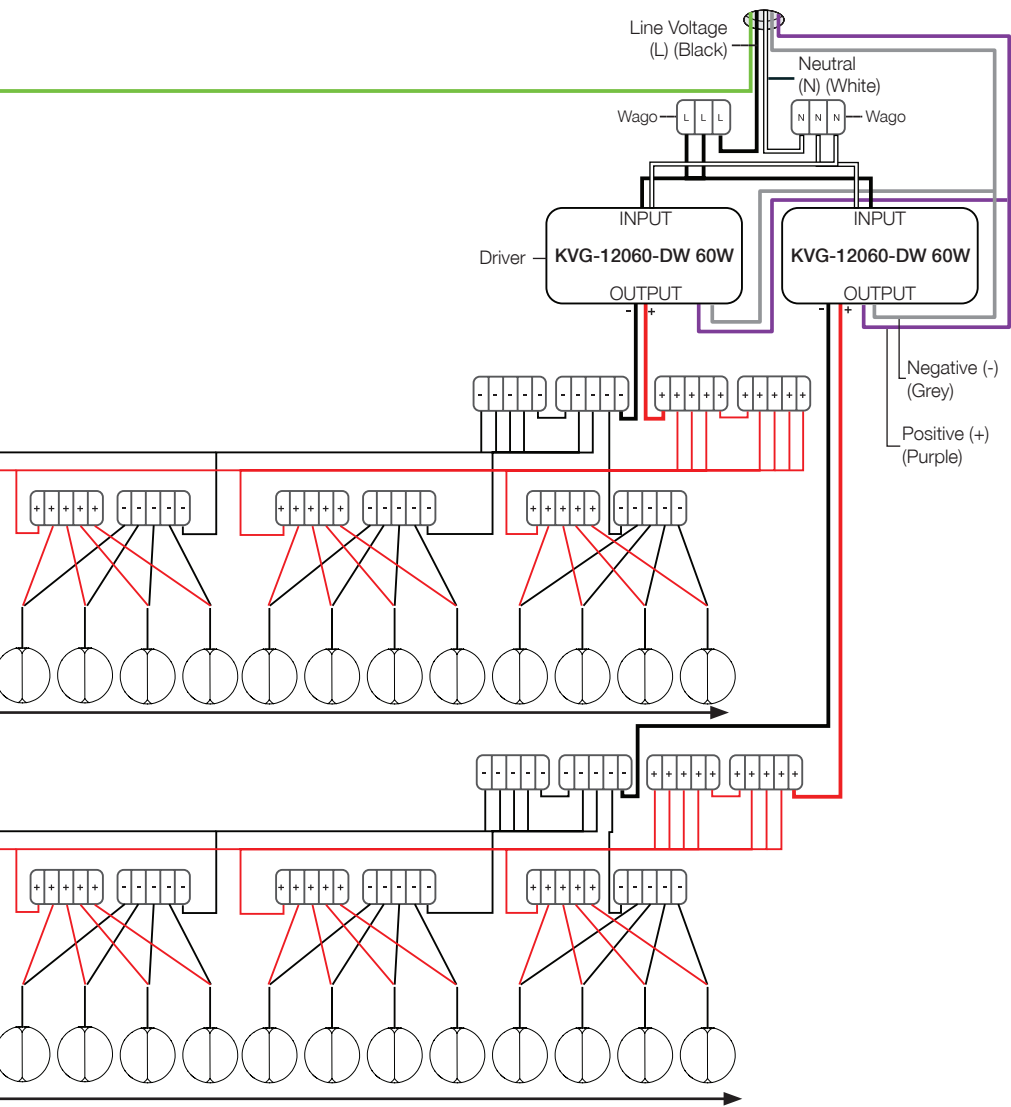

**NOTE: Outside of North America, the Neutral and Line Voltage wire colours may be different.**







MATTHEW McCORMICK

12-2023